

# PTS645 Series 6 mm Tact Switches



## Features/Benefits

- Compact size 6 x 6 mm
- Variety of actuator lengths
- Choice of actuation force
- RoHS compliant and compatible

## Typical Applications

- Consumer products
- Instrumentation
- Computer products
- Industrial

## Specification

FUNCTION: Momentary action  
CONTACT ARRANGEMENT: SPST, N.O.  
TERMINALS: PC pins

## Mechanical

ACTUATION FORCE: PTS645 models: 130 grams, 160 grams,  
200 grams, 260 grams  
LIFE EXPECTANCY: 100,000 operations.

## Electrical

CONTACT RATING: 50 mA @ 12 V DC.  
DIELECTRIC STRENGTH: 250 V AC min.  
CONTACT RESISTANCE: 100 mΩ max. initial.  
INSULATION RESISTANCE: 10<sup>11</sup> Ω min.

## Environmental

OPERATING TEMPERATURE: -20°C to 60°C

**NOTE:** Specifications listed above are for switches with standard options.  
For information on specific and custom switches, consult Customer Service Center.

## Process

SOLDERING: Preheating to 100°C for 45 sec. max. Keep flux flush with top surface of PCB; do not apply to component side of PCB and area where terminals are located. Soldering to 255°C for 5 sec. max. Clean by brushing on solder surface. Do not clean switch with solvents.

## Materials

BASE: 6/6 nylon or glass filled polyester (PBT) (UL 94V-0).  
ACTUATOR: 6/6 nylon or polyacetal (UL 94HB).  
COVER PLATE: PTS645S: Polyester or stainless steel.  
PTS645T and PTS645V: Tin alloy or stainless steel.  
DOME CONTACTS: Phosphor bronze, silver clad.  
STATIONARY CONTACTS: Brass, silver plated.  
TERMINALS: Brass, silver plated. Insert molded.

## Packaging

Bulk packaging.

### Tape & reel for the SMT type:

Reel of 1000 pcs for the PST645Sx43 & 50  
Reel of 750 pcs for the PTS645Sx70  
Reel of 500 pcs for the PTS645Sx95

## How To Order

Our easy build-a-switch concept allows you to mix and match options to create the switch you need. To order, select desired option from each category and place it in the appropriate box.

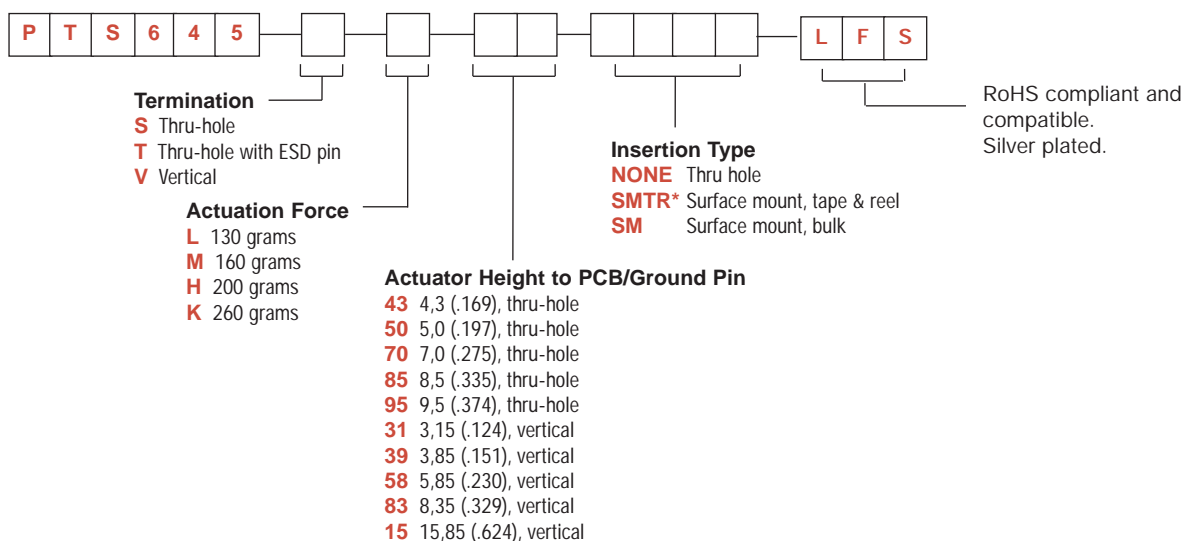

\*Only the PTS645 in horizontal type without ESD pin is available in SMT type.

# PTS645 Series 6 mm Tact Switches

## SERIES

### PTS645

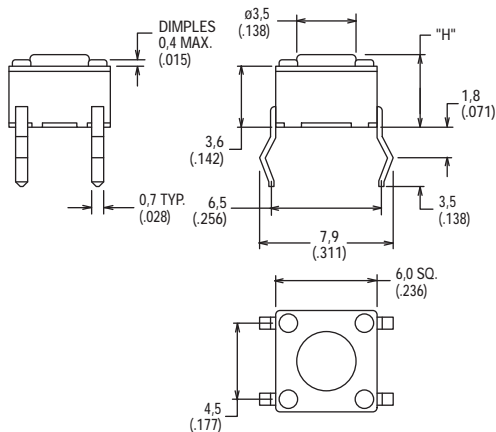

PTS645S Model

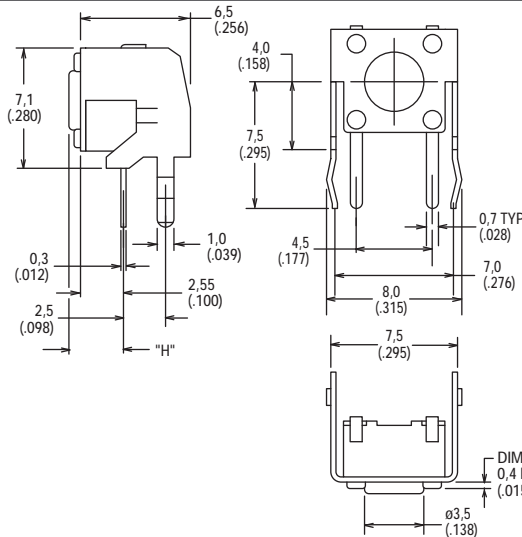

PTS645V Model

## TERMINATION

### S STRAIGHT

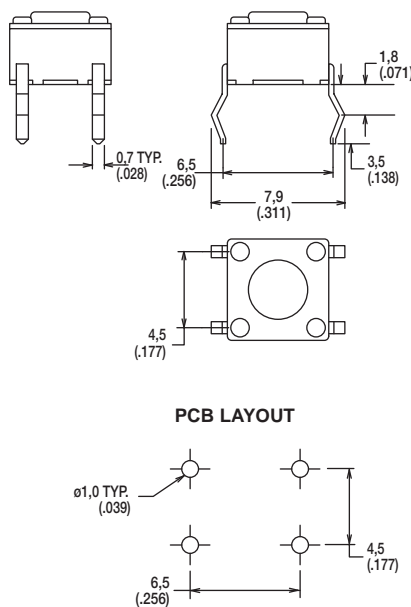

### T STRAIGHT WITH EMC PIN

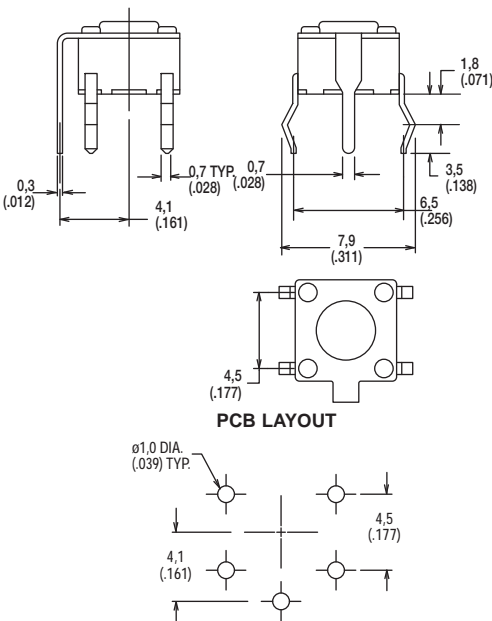

### V VERTICAL

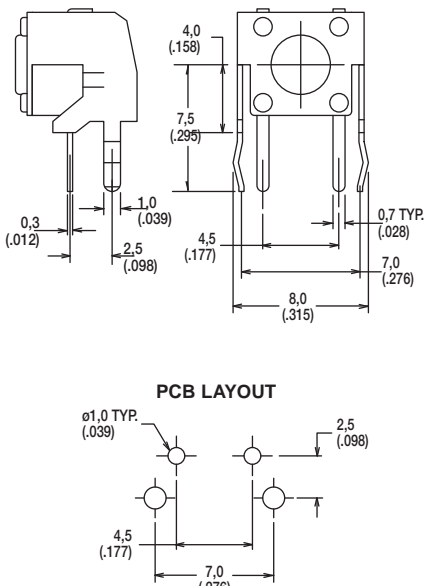

### SMT

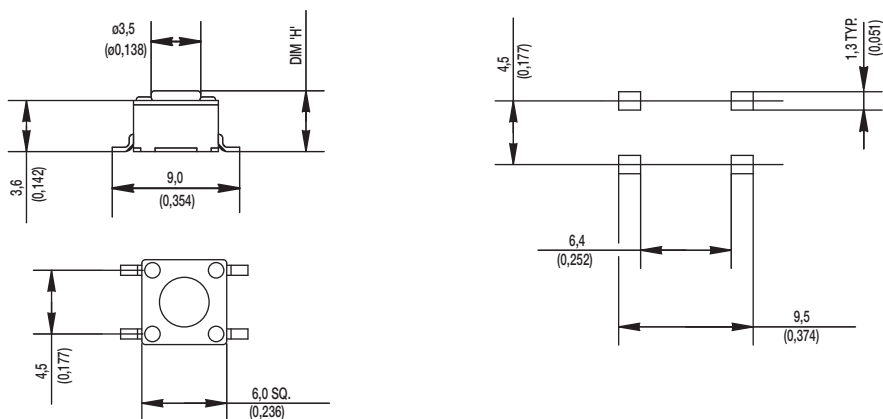

Dimensions shown in: mm (inch)  
Specifications and dimensions subject to change









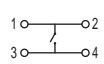
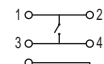

www.ck-components.com

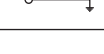
# PTS645 Series 6 mm Tact Switches

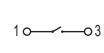
## ACTUATION FORCE

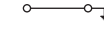
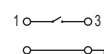
OPTION CODE	FORCE
<b>L</b>	130 grams
<b>M</b>	160 grams
<b>H</b>	200 grams
<b>K</b>	260 grams

## ACTUATOR HEIGHT

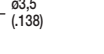
OPTION CODE	HEIGHT "H" or LENGTH "L"	TERMINATION	SCHEMATIC	
			Without EMC pin	With EMC pin
<b>43</b>	4,3 (.169)	Thru-hole		
<b>50</b>	5,0 (.197)	Thru-hole		
<b>70</b>	7,0 (.275)	Thru-hole		
<b>95</b>	9,5 (.374)	Thru-hole		
<b>31</b>	3,15 (.124)	Vertical		
<b>39</b>	3,85 (.151)	Vertical		
<b>58</b>	5,85 (.230)	Vertical		
<b>83</b>	8,35 (.329)	Vertical		
<b>15</b>	15,85 (.624)	Vertical		

**43**

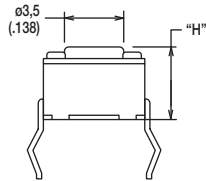

**50**

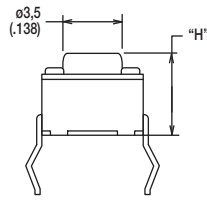

**70**

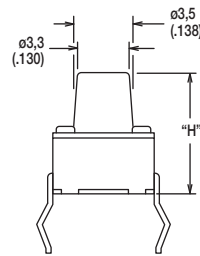

**85**

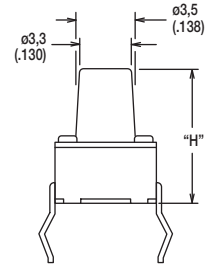

**95**

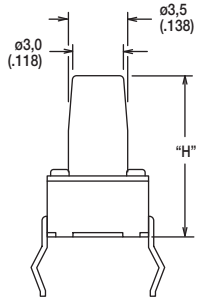

**31**

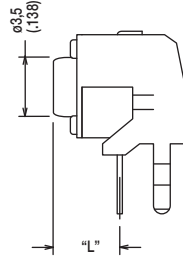

**39**

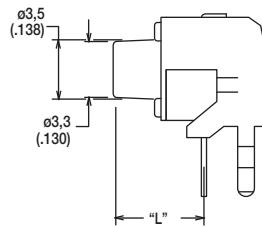

**58**

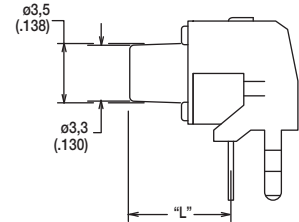

**83**

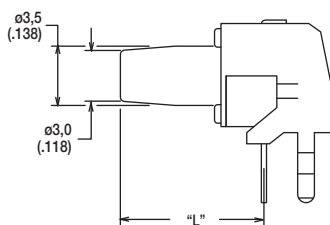

**15**

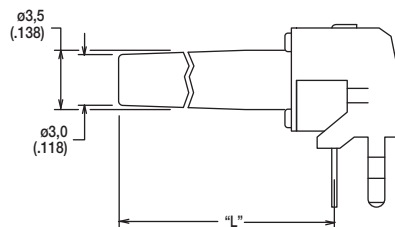

First Angle Projection

Dimensions shown in: mm (inch)  
Specifications and dimensions subject to change

www.ck-components.com